

CATALOGUE
01 September 2023

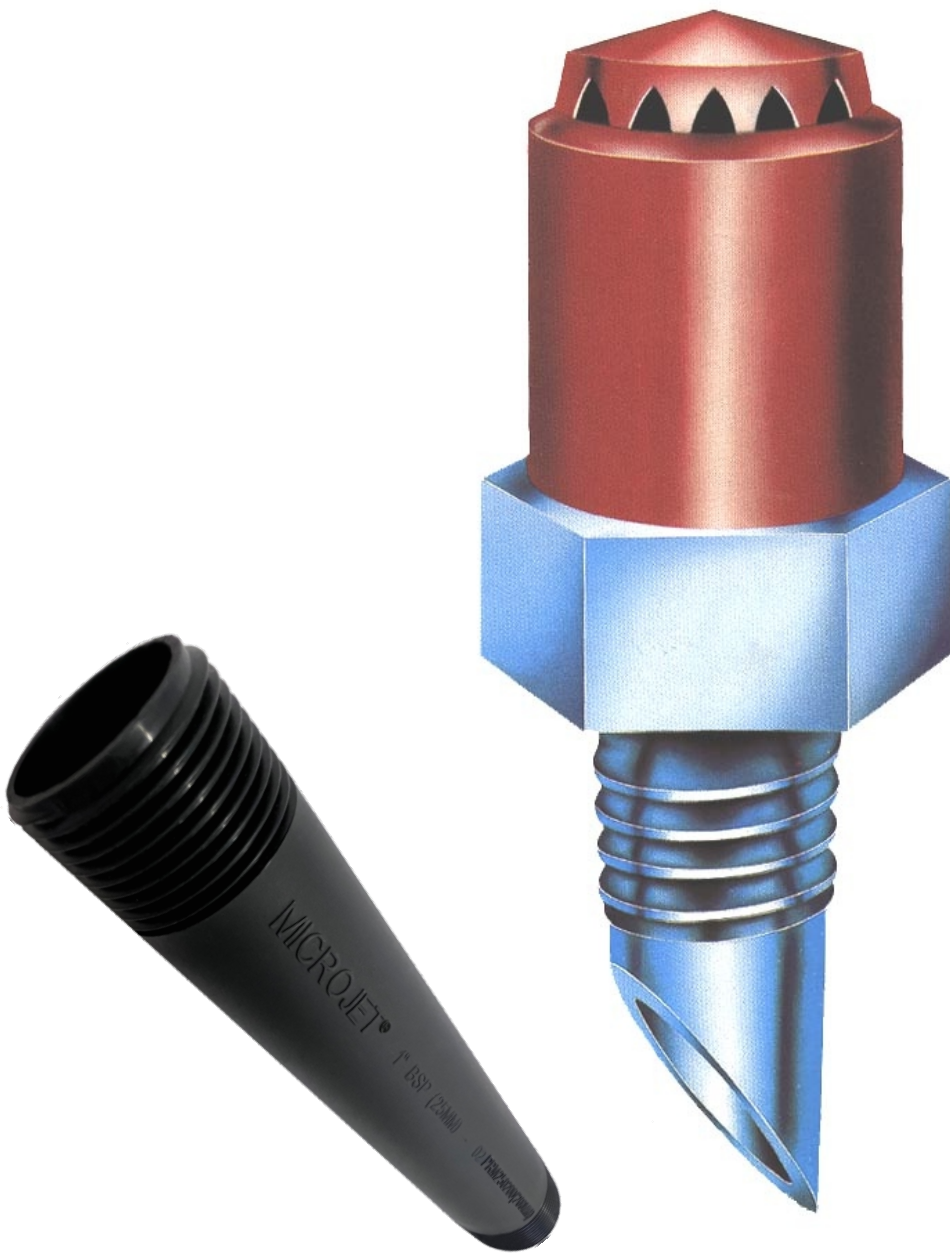

MICROJET®

IRRIGATION SYSTEMS

P.O. Box 279, Eppindust, 7475
Tel : (021) 535 1310
email : info@microjet.co.za
<http://www.microjet.co.za>

TERMS AND CONDITIONS

Note: In these terms and conditions the name Microjet is to be taken to mean Micromark (Pty) Ltd, Micro Mouldings (Pty) Ltd, Microjet (Pty) Ltd or any other company which supplies these products as direct agents of the manufacturer, Micro Mouldings (Pty) Ltd

All orders placed on Microjet are subject to the following Terms and Conditions:

- Until such time as the purchase price of the goods delivered has been paid in full, ownership in the goods supplied shall remain vested in Microjet and shall not pass to the customer.

- Any credit facilities which may be granted are subject to payment strictly 30 days nett from date of monthly statement. Any settlement discounts will only be applied to payments made on or before the last working day of the month in which they are due.

- All goods are to be ordered using Microjet **product code numbers, descriptions and prices**. This will eliminate the risk of the incorrect goods being supplied. Microjet will not be responsible for any errors made on orders not containing full Microjet codes and descriptions or incorrect prices.

- A minimum value of R 3,000.00 per order will apply to all orders.

- Pack quantities as per this pricelist will apply to all orders. Any items ordered less than the minimum pack quantity will be rounded up to the nearest pack quantity.

- A minimum lead time of 72 hours is required for filling of orders.

- All prices are ex factory (Cape Town) and exclude VAT.

- All products will be charged at the rulling price as per this price list or any advertised change in the price by Microjet. In the event of any price dispute the current Microjet list price will apply. Microjet will not check nor confirm pricing nor any other information on orders before despatch and invoicing.

ACCEPTABLE USE

All Items are designed for use in outdoor irrigation systems at optimal irrigation temperatures and pressures only.

BARCODED PRODUCT

All items marked with a "B" next to the price are supplied barcoded. Only the individual items are barcoded. No inner or outer barcodes or special packaging are included in the price.

Barcoded stock is supplied and handled in the same manner as un-barcoded Stock. Namely in clear poly bags as per the pack quantity specified.

While every effort is made to ensure that barcode labels remain firmly affixed to the product, product from which the barcode label may have come off do not qualify as defective.

Barcoded items can be ordered un-barcoded but there will be no discount offered for this. Customers may experience delays as un-barcoded items such as these are not stock items. Any such orders of un-barcoded product need to approved by the Sales Manager.

GOODS RETURNS POLICY:

Any defective or factory damaged goods will be replaced or credited on application.

Short supply – All goods are supplied ex factory and are signed for as correct by whomever the customer has sent to collect such goods (including couriers and drivers appointed by the customer). Any claim for short supplied goods will only be effected if we are advised within 48 hours of the goods being received. Any claim will be checked against our system to verify that the goods were short supplied and if correct will be resupplied or credited.

Should you wish to return any goods for any other reason, authorisation must first be obtained from the Sales Manager. A handling fee of **20%** will be levied on all such returns.



DESCRIPTION	CODE	SIZE	PACK	
<p>MICROJET CAP, BLACK</p>	AB 01 AB 02 AB 03 AB 04 AB 05 AB 06 AB 07 AB 08 AB 09 AB 10	40° STRIP 360° X 15 360° X 12 300° X 10 280° 270° 180° OPEN 180° X 8 90° 20°	1000 1000 1000 1000 1000 1000 1000 1000 1000 1000	
<p>MAXI-CAP, BLACK</p>	AM 01 AM 05	180° 360°	1000 1000	
<p>MICROJET BASE</p>	BLACK BLUE GREEN RED WHITE	BB 01 BB 02 BB 03 BB 04 BB 05	0.8mm (-.030") 1.0mm (-.040") 1.3mm (-.050") 1.5mm (-.060") 2.3mm (-.090")	1000 1000 1000 1000 1000
<p>ASSEMBLED MICROJETS (BLACK CAP)</p>	BLACK BLUE GREEN RED WHITE MAXI-CAP	BB01AB?? BB02AB?? BB03AB?? BB04AB?? BB05AB?? BB??AM??	PLEASE NOTE : Coding structure for assembled jets : BASE CODE+CAP CODE (e.g. BB01AB01) - replace question marks with appropriate code numbers	1000 1000 1000 1000 1000 1000
<p>VARIJET</p>	BV 40 BV40AB?? BV40FJ??	1.0mm (-.040") - NO CAP Assembled with cap (?? = cap code) Assembled with Framejet (??? = framejet code)	500 500 500	
<p>MICROJET C-SERIES</p>	BLACK BLUE GREEN RED	BC 10 BC 01 BC 02 BC 03	0.8mm (-.030") 1.0mm (-.040") 1.3mm (-.050") 1.5mm (-.060")	1000 1000 1000 1000
<p>MICROJET FRAME-JET</p>	BLACK BLUE GREEN RED WHITE BLACK BLUE GREEN RED WHITE BLACK BLUE GREEN RED WHITE	FJF 30 FJF 40 FJF 50 FJF 60 FJF 90 FJH 30 FJH 40 FJH 50 FJH 60 FJH 90 FJQ 30 FJQ 40 FJQ 50 FJQ 60 FJQ 90	0.8mm (-.030") x 360° 1.0mm (-.040") x 360° 1.3mm (-.050") x 360° 1.5mm (-.060") x 360° 2.3mm (-.090") x 360° 0.8mm (-.030") x 180° 1.0mm (-.040") x 180° 1.3mm (-.050") x 180° 1.5mm (-.060") x 180° 2.3mm (-.090") x 180° 0.8mm (-.030") x 90° 1.0mm (-.040") x 90° 1.3mm (-.050") x 90° 1.5mm (-.050") x 90° 2.3mm (-.090") x 90°	1000 1000 1000 1000 1000 1000 1000 1000 1000 1000 1000 1000 1000 1000 1000 1000 1000 1000 1000



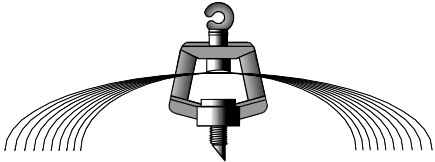
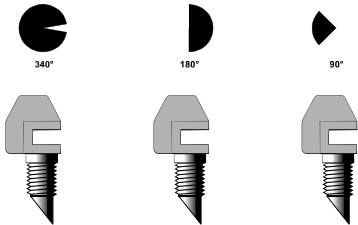
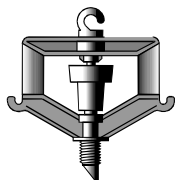
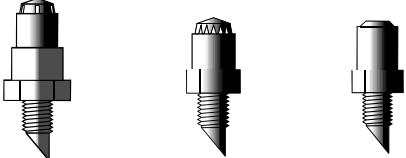



**NB: All Jets and Adaptors are available in 100 packs for an additional charge
 Please use the usual code with -100 behind it (eg: AB01-100)**

DESCRIPTION	CODE	SIZE	PACK
 <p>MICROJET FRAME JET - DOWNSPRAY 360°</p>	BLACK FJD 30 BLUE FJD 40 GREEN FJD 50 RED FJD 60 WHITE FJD 90	0.8mm (-.030") x 360° 1.0mm (-.040") x 360° 1.3mm (-.050") x 360° 1.5mm (-.060") x 360° 2.3mm (-.090") x 360°	1000 1000 1000 1000 1000
 <p>SUNJET (1 PIECE JET)</p>	BLACK SJF 30 BLUE SJF 40 GREEN SJF 50 RED SJF 60 BLACK SJH 30 BLUE SJH 40 GREEN SJH 50 RED SJH 60 BLACK SJQ 30 BLUE SJQ 40 GREEN SJQ 50 RED SJQ 60	0.8mm (-.030") x 340° 1.0mm (-.040") x 340° 1.3mm (-.050") x 340° 1.5mm (-.060") x 340° 0.8mm (-.030") x 180° 1.0mm (-.040") x 180° 1.3mm (-.050") x 180° 1.5mm (-.060") x 180° 0.8mm (-.030") x 90° 1.0mm (-.040") x 90° 1.3mm (-.050") x 90° 1.5mm (-.060") x 90°	1000 1000 1000 1000 1000 1000 1000 1000 1000 1000 1000 1000
 <p>MICROSPIN</p>	BLACK BD 30 ORANGE BD 35 BLUE BD 40 GREEN BD 50 RED BD 60	0.8mm (-.030") 0.9mm (-.035") 1.0mm (-.040") 1.3mm (-.050") 1.5mm (-.060")	100 100 100 100 100
 <p>SPECIALITY JETS</p>	BD 01 BE 01 BF 01	Lighthouse Jet - with rotating cap Ball Drive Jet - White Base Mistspray Jet	500 1000 1000

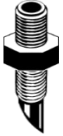
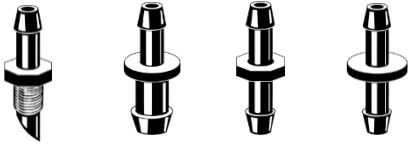
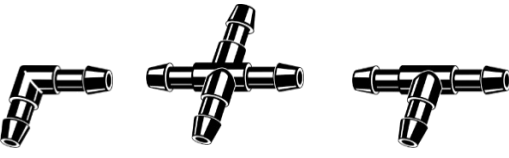

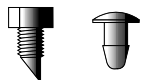
MICROJET® POP-UP SPRINKLERS

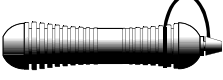
DESCRIPTION	CODE	SIZE	PACK
 <p>MICROJET POP-UP SPRINKLER - 4"</p>	FC400	4" Pop-up Body (No Nozzle) All Pop-up components are available as spares	1

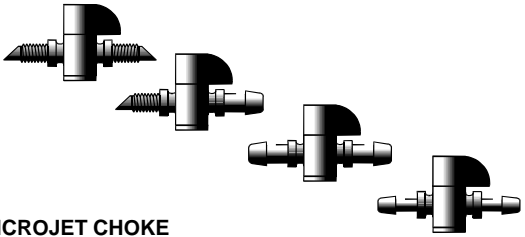

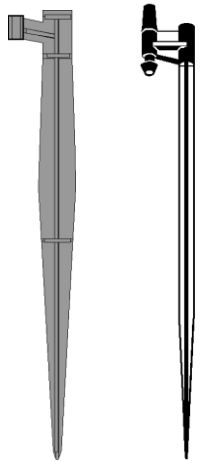
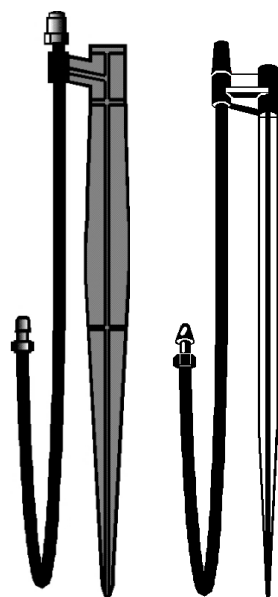

**NB: All Jets and Adaptors are available in 100 packs for an additional charge
Please use the usual code with -100 behind it (eg: AB01-100)**

DESCRIPTION	CODE	SIZE	PACK
    ADAPTORS & TUBE FITTINGS	BG 02 BG 04 BG 14 BG 18 BH 14 BH 15 BH 16 BH 17 BH 19 BH 21 BH 23 BH 35 BH 38	RISER ADAPTORS Threaded 2BA TUBE ADAPTORS: 5mm x 2ba 4.5mm x 2ba 4mm x 5mm - Barbed 4mm x 4mm - Barbed (Hex) 4mm x 4mm - Barbed (Disc) 5mm x 5mm - Barbed (Disc) 6mm x 6mm - Barbed (Disc) TUBE FITTINGS Elbow: 4.5mm Crosspiece: 4.5mm Tee-piece: 4.5mm 4mm JET ADAPTORS (for Stake Assembly) REINFORCED (for threaded jets) BLUE HEAD (for pressfit jets)	1000 1000 1000 1000 1000 1000 1000 1000 1000 1000 1000 1000
BLANK PLUGS 	BG 05 BG 06	SCREWED 2BA BARBED	1000 1000
MICROJET SPANNER  MICROJET PUNCH 	BG 01 BG 07 BG 08 BG 11 BG 09	Plastic Spike Chrome Spike for Lighthouse for Sunjet Punch	25 25 25 25 10
RIGID RISER with ADAPTOR 	BJ 02 BJ 04 BJ 06 BJ 10	200mm (Nominal) 300mm (Nominal) 450mm (Nominal) 1000 mm (Nominal) Non-Standard lengths available on request	1000 1000 1000 1000
MICROJET CHOKE 	BK 61 BK 62 BK 63 BK 65	THREADED 2BA THEADED/BARBED BARBED 5mm BARBED 4.5mm	100 100 100 100

**NB: All Jets and Adaptors are available in 100 packs for an additional charge
 Please use the usual code with -100 behind it (eg: AB01-100)**

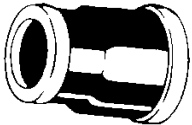
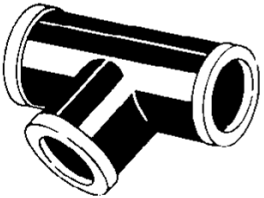
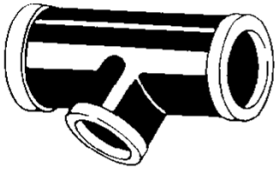
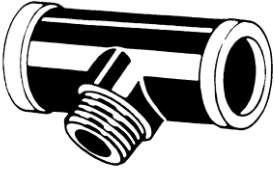
DESCRIPTION	CODE	SIZE	PACK		
 MICROJET STAKE	STANDARD STAKE (ABS)	BS 100 BS 200 BS 300 BS 450	150mm 200mm 300mm 450mm	500 500 500 300	
	STANDARD POLYSTAKE	BP 300 BP 450	300mm 450mm	500 300	
	POLY SLIMSTAKE	BPS 300B BPS 300C BPS 450B BPS 450C	300mm BARB 300mm CLIP 450mm BARB 450mm CLIP	100 100 100 100	
	BLUE HEAD SLIMSTAKE	BBS 300B BBS 450B	300mm BARB (for pressfit) 450mm BARB (for pressfit)	100 100	
	STAKEHEAD ONLY	BSH100	BARBED - For Aluminium Stake	100	
	FLEXIBLE TUBE GUIDE	BH 40	Only available with SLIMSTAKE	100	
	Complete Stake Assembly: Stake, 600mm Tube, Barbed Adaptor, Jet:				
	 MICROJET STAKE ASSEMBLY	STANDARD STAKE	BS3/JET CODE	300mm	100
		STANDARD STAKE	BS4/JET CODE	450mm	100
		STANDARD POLYSTAKE	BP3/JET CODE	300mm	100
STANDARD POLYSTAKE		BP4/JET CODE	450mm	100	
POLY SLIMSTAKE		BPS3/JET CODE	300mm	100	
POLY SLIMSTAKE		BPS4/JET CODE	450mm	100	
Incomplete Stake Assembly: Stake, 600mm Tube, Barbed Adaptor - No Jet:					
STANDARD STAKE		BSA 300	300mm - no jet	100	
STANDARD STAKE		BSA 450	450mm - no jet	100	
STANDARD POLYSTAKE		BPA 300	300mm - no jet	100	
STANDARD POLYSTAKE	BPA 450	450mm - no jet	100		
POLY SLIMSTAKE	BPSA 300	300mm - no jet	100		
POLY SLIMSTAKE	BPSA 450	450mm - no jet	100		
BLUE HEAD SLIMSTAKE	BBSA 300	300mm - no jet (for pressfit)	100		
BLUE HEAD SLIMSTAKE	BBSA 450	450mm - no jet (for pressfit)	100		
Potstake Assembly: 150 Stake, 100mm riser, Downspray 360°, Barbed Adaptor (no tubing):					
STANDARD POTSTAKE	BS1FJD	with Framejet Downspray	100		
AJUSTABLE POTSTAKE	BS1BVD	with Varijet Downspray	100		
 FLEXIBLE PVC TUBE	BHD 100	3mm Drip Tube - BLACK	100m		
	BH 100	4mm - BLACK	100m		
	BH 200	4mm - BLACK	200m		
	BH 100G	4mm - GREEN	100m		
	BH 105	5mm - BLACK	100m		
	CUT LENGTHS	BH 60	4mm BLACK - with adaptor	600mm	
	CUT LENGTHS	BH 1000	4mm BLACK - with adaptor	1m	
<i>non-standard lengths available on request</i>					

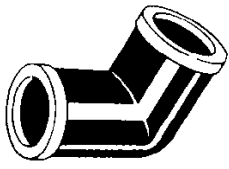



DESCRIPTION	CODE	SIZE	PACK
 CONNECTOR	FF 1001 FF 1002 FF 1003 FF 1040	13mm 15mm 20mm 25mm	20 20 20 20
 REDUCER	FF 1004 FF 1120 FF 1005 FF 1110 FF 1045	15mm x 13mm 20mm x 13mm 20mm x 15mm 25mm x 15mm 25mm x 20mm	20 20 20 20 20
 TEEPIECE	FF 1006 FF 1007 FF 1008 FF 1050	13mm 15mm 20mm 25mm	20 20 20 20
 REDUCING TEEPIECE	FF 1028 FF 1024 FF 1025 FF 1070 FF 1105	15mm x 13mm 20mm x 13mm 20mm x 15mm 25mm x 15mm 25mm x 20mm	20 20 20 20 20
 MALE COMBINATION TEEPIECE	FF 1180 FF 1009 FF 1182 FF 1010 FF 1011 FF 1080 FF 1089 FF 1300	13mm x 1/2" 15mm x 1/2" 15mm x 3/4" 20mm x 3/4" 20mm x 1/2" 25mm x 1/2" 25mm x 3/4" 25mm x 1"	20 20 20 20 20 20 20 20
 FEMALE COMBINATION TEEPIECE	FF 2130 FF 2140 FF 2150 FF 2160	20mm x 1/2" 20mm x 3/4" 25mm x 1/2" 25mm x 3/4"	20 20 20 20
 ELBOW	FF 1012 FF 1013 FF 1014 FF 1060	13mm 15mm 20mm 25mm	20 20 20 20
 REDUCING ELBOW	FF 1256	20mm x 15mm	20

This Supersedes ALL Previous Catalogues

EFFECTIVE 01 September 2023

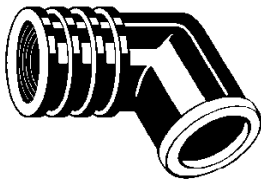
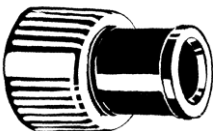
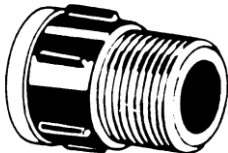

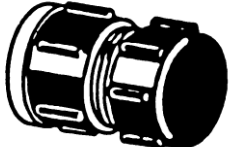
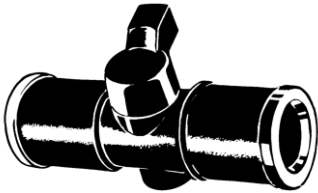

DESCRIPTION	CODE	SIZE	PACK
 MALE COMBINATION ELBOW	FF 1190	13mm x 1/2"	20
	FF 1015	15mm x 1/2"	20
	FF 1192	15mm x 3/4"	20
	FF 1016	20mm x 3/4"	20
	FF 1017	20mm x 1/2"	20
	FF 1092	20mm x 1"	20
	FF 1096	25mm x 1/2"	20
	FF 1100	25mm x 3/4"	20
	FF 1350	25mm x 1"	20
 FEMALE COMBINATION ELBOW	FF 2220	15mm x 1/2"	20
	FF 2240	20mm x 1/2"	20
	FF 2250	20mm x 3/4"	20
	FF 2260	25mm x 1/2"	20
	FF 2270	25mm x 3/4"	20
 TAP CONNECTOR	FF 1410	13mm x 3/4"	20
 P X MI ADAPTOR	FF 1021	15mm x 1/2"	20
	FF 1032	15mm x 3/4"	20
	FF 1033	20mm x 1/2"	20
	FF 1022	20mm x 3/4"	20
	FF 1034	20mm x 1"	20
	FF 1036	25mm x 1/2"	20
	FF 1037	25mm x 3/4"	20
	FF 1035	25mm x 1"	20
 END PLUG	FF 1018	13mm	20
	FF 1019	15mm	20
	FF 1020	20mm	20
	FF 1030	25mm	20
 DRAIN VALVE, 3/4" BSP NUT	FF 1023	20mm	20
	FF 1026	25mm	20
 FLOW CONTROL	FF 1140	13mm	20
	FF 1150	15mm	20
	FF 1160	20mm	20



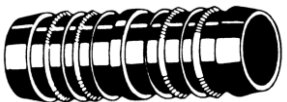
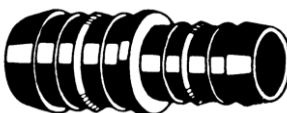

This Supersedes ALL Previous Catalogues

EFFECTIVE 01 September 2023



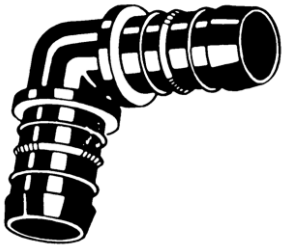

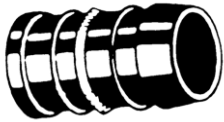
DESCRIPTION	CODE	SIZE	PACK
 <p>CONNECTOR</p>	MB 100	10mm	20
	MB 101	13mm	20
	MB 102	15mm	20
	MB 103	20mm	20
	MB 104	25mm	20
	MB 200	32mm	20
	MB 205	40mm	20
	MB 206	50mm	10
	MB 207	50mm - LONG	10
	MB 208	65mm	10
	MB 209	80mm	5
 <p>REDUCER</p>	MB 105	13mm x 10mm	20
	MB 106	15mm x 10mm	20
	MB 107	15mm x 13mm	20
	MB 108	20mm x 10mm	20
	MB 109	20mm x 13mm	20
	MB 110	20mm x 15mm	20
	MB 111	25mm x 15mm	20
	MB 112	25mm x 20mm	20
	MB 223	32mm x 15mm	20
	MB 224	32mm x 20mm	20
	MB 225	32mm x 25mm	20
	MB 226	40mm x 15mm	20
	MB 227	40mm x 20mm	20
	MB 228	40mm x 25mm	20
	MB 229	40mm x 32mm	20
	MB 231	50mm x 15mm	10
	MB 232	50mm x 20mm	10
	MB 233	50mm x 25mm	10
	MB 234	50mm x 32mm	10
	MB 235	50mm x 40mm	10
MB 237	65mm x 50mm	10	
MB 238	80mm x 50mm	5	
MB 239	80mm x 65mm	5	
 <p>EQUAL TEEPIECE</p>	MB 113	10mm	20
	MB 115	13mm	20
	MB 117	15mm	20
	MB 119	20mm	20
	MB 120	25mm	20
	MB 325	32mm	20
	MB 330	40mm	20
	MB 331	50mm	10
	MB 332	65mm	10
	MB 333	80mm	5
 <p>REDUCING TEEPIECE</p>	MB 114	13mm x 10mm	20
	MB 116	15mm x 13mm	20
	MB 118	20mm x 15mm	20
	MB 121	25mm x 20mm	20
	MB 122	25mm x 15mm	20
	MB 334	32mm x 15mm	20
	MB 335	32mm x 20mm	20
	MB 336	32mm x 25mm	20
	MB 338	40mm x 15mm	20
	MB 339	40mm x 20mm	20
	MB 340	40mm x 25mm	20
	MB 341	40mm x 32mm	20
	MB 343	50mm x 15mm	10
	MB 344	50mm x 20mm	10
	MB 345	50mm x 25mm	10
	MB 346	50mm x 32mm	10
MB 347	50mm x 40mm	10	





DESCRIPTION	CODE	SIZE	PACK
ELBOW 	MB 127	10mm	20
	MB 128	13mm	20
	MB 129	15mm	20
	MB 130	20mm	20
	MB 131	25mm	20
	MB 240	32mm	20
	MB 245	40mm	20
	MB 246	50mm	10
	MB 247	65mm	10
	MB 248	80mm	5
REDUCING ELBOW 	MB 300	15mm x 13mm	20
END PLUG 	MB 136	10mm	20
	MB 137	13mm	20
	MB 138	15mm	20
	MB 139	20mm	20
	MB 140	25mm	20
	MB 260	32mm	20
	MB 261	40mm	20
	MB 262	50mm	10
	MB 263	65mm	10
	MB 264	80mm	5
	MALE COMBINATION TEEPIECE 	MB 123	13/15mm x 1/2"
MB 124		15mm x 1/2"	20
MB 125		20mm x 1/2"	20
MB 126		20mm x 3/4"	20
MB 210		25mm x 1/2"	20
MB 212		25mm x 3/4"	20
MB 214		25mm x 1"	20
MB 215		32mm x 1/2"	20
MB 216		32mm x 3/4"	20
MB 217		32mm x 1"	20
MB 218		32mm x 1 1/4"	20
MB 249		40mm x 1/2"	20
MB 250		40mm x 3/4"	20
MB 251		40mm x 1"	20
MB 252		40mm x 1 1/4"	20
MB 253		40mm x 1 1/2"	20
MB 254		50mm x 1/2"	10
MB 255		50mm x 3/4"	10
MB 256		50mm x 1"	10
MB 257		50mm x 1 1/4"	10
MB 258	50mm x 1 1/2"	10	
MB 259	50mm x 2"	10	
MALE COMBINATION ELBOW 	MB 132	13/15mm x 1/2"	20
	MB 133	15mm x 1/2"	20
	MB 134	20mm x 1/2"	20
	MB 135	20mm x 3/4"	20
	MB 279	20mm x 3/4" - LONG	20
	MB 280	25mm x 1/2"	20
	MB 282	25mm x 3/4"	20
	MB 284	25mm x 1"	20
	MB 286	32mm x 1 1/4"	20
	MB 289	40mm x 1 1/2"	20
	MB 290	40mm x 2"	20
	MB 291	50mm x 2"	10
	MB 292	50mm x 1 1/2"	10

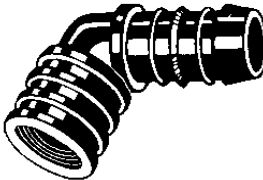
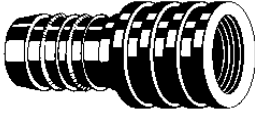



DESCRIPTION	CODE	SIZE	PACK
 P X MI ADAPTOR	MB 141	13mm x 1/2"	20
	MB 265	13mm x 3/4"	20
	MB 142	15mm x 1/2"	20
	MB 266	15mm x 3/4"	20
	MB 143	20mm x 3/4"	20
	MB 620	20mm x 1"	20
	MB 144	25mm x 1"	20
	MB 267	25mm x 1 1/4"	20
	MB 269	32mm x 1"	20
	MB 270	32mm x 1 1/4"	20
	MB 271	32mm x 1 1/2"	20
	MB 275	40mm x 1 1/2"	20
	MB 274	40mm x 2"	10
	MB 276	50mm x 2"	10
	MB 277	65mm x 2 1/2"	5
	MB 278	80mm x 3"	5
 FEMALE COMBINATION TEEPIECE	MB 702	15mm x 1/2"	20
	MB 703	20mm x 1/2"	20
	MB 704	20mm x 3/4"	20
	MB 705	25mm X 1/2"	20
	MB 706	25mm X 3/4"	20
	MB 707	25mm X 1"	20
	MB 708	32mm x 1/2"	20
	MB 709	32mm x 3/4"	20
	MB 710	32mm x 1"	20
	MB 711	32mm x 1 1/4"	20
	MB 712	40mm x 1/2"	20
	MB 713	40mm x 3/4"	20
	MB 714	40mm x 1"	20
	MB 715	40mm x 1 1/4"	20
	MB 716	40mm x 1 1/2"	20
	MB 719	50mm x 3/4"	10
	MB 720	50mm x 1"	10
	MB 721	50mm x 1 1/4"	10
MB 722	50mm x 1 1/2"	10	
MB 723	50mm x 2"	10	
 FEMALE COMBINATION ELBOW	MB 732	15mm x 1/2"	20
	MB 733	20mm x 1/2"	20
	MB 734	20mm x 3/4"	20
	MB 735	25mm X 1/2"	20
	MB 736	25mm X 3/4"	20
	MB 737	25mm x 1"	20
	MB 741	32mm x 1 1/4"	20
	MB 746	40mm x 1 1/2"	20
	MB 752	50mm x 2"	10
 FEMALE ADAPTOR (P x FI)	MB 762	15mm x 1/2"	20
	MB 764	20mm x 3/4"	20
	MB 765	25mm x 1"	20
	MB 767	40mm x 1 1/2"	20

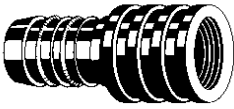



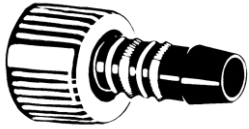

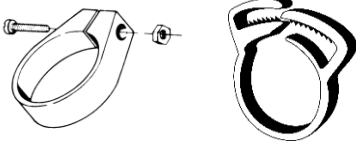
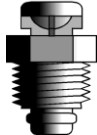

DESCRIPTION	CODE	SIZE	PACK
 MALE FEMALE ADAPTOR GREEN POLYPROP (MNPT/ FBSP)	MBG 571	¾" MNPT x FBSP (20mm)	20
 FLOW BIN ADAPTOR GREEN POLYPROP 2'	MBG 657	2" BSP x Buttress	10
 FEMALE ADAPTOR GREEN POLYPROP	MBG 762 MBG 764	15mm x 1/2" - Green 20mm x 3/4" - Green	20 20

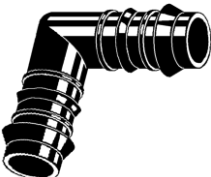
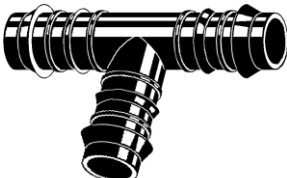
EMJAY[®] INSERT FITTINGS



DESCRIPTION	CODE	SIZE	PACK
 FLOW CONTROL	MB 400 MB 405 MB 410	13mm 15mm 20mm	20 20 20
 TAP CONNECTOR	MB 149 MB 150 MB 151 MB 152 MB 153 MB 605	13mm x 5/8" 13mm x 3/4" 20mm x 7/8" 15mm x 7/8" 15mm x 5/8" 15mm x 3/4"	20 20 20 20 20 20
 HOSE TAIL	MB 145 MB 146 MB 147 MB 148	13mm x 3/4" BSP 13mm x 3/4" USA 20mm x 3/4" BSP 20mm x 3/4" USA	20 20 20 20
 HOSE CLAMP	MB 154 MB 155 MB 156 MB 157 MB 158 MB 195	17mm - Nut & Bolt 19mm - Nut & Bolt 24mm - Nut & Bolt 27mm - Nut & Bolt 30mm - Nut & Bolt 32mm - Ratchet	20 20 20 20 20 20
 VACUUM BREAKER	MB 180	15mm	20



DESCRIPTION	CODE	SIZE	PACK
 CONNECTOR	MDA116 MDA117	16mm - Black 17mm - Brown	20 20
 ELBOW	MDA216 MDA217	16mm - Black 17mm - Brown	20 20
 TEE	MDA316 MDA317	16mm - Black 17mm - Brown	20 20
 MALE ADAPTOR (PxMI)	MDA416 MDA516 MDA417 MDA517	16mm x 1/2" BSP - Black 16mm x 3/4" BSP - Black 17mm x 1/2" BSP - Brown 17mm x 3/4" BSP - Brown	20 20 20 20
 MALE TEE	MDA616 MDA617	16mm x 1/2" BSP - Black 17mm x 1/2" BSP - Brown	20 20
 FEMALE TEE	MDA716 MDA717	16mm x 1/2" BSP - Black 17mm x 1/2" BSP - Brown	20 20
 START CONNECTOR	MDA816 MDA817	16mm - Black 17mm - Brown	20 20
 GROMMET FITTING	MDA917	17mm x No.5 - Brown	20

This Supersedes ALL Previous Catalogues

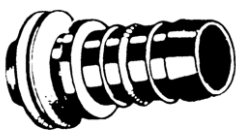

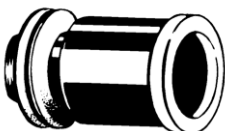

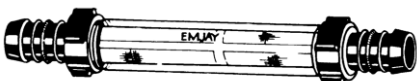
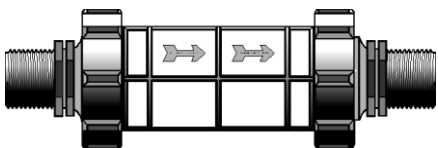
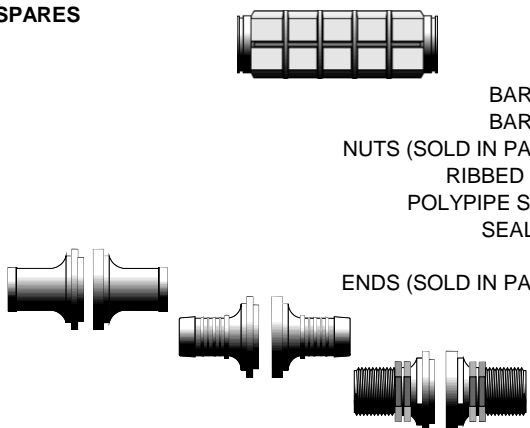

EFFECTIVE 01 September 2023

DESCRIPTION	CODE	SIZE	PACK
 EMJAY GROMMET FITTING	GF 100	15mm x No.5	20
	GF 101	20mm x No.5	20
	GF 102	20mm x No.6	20
	GF 103	25mm x No.6	20
	GF 108	25mm x No.8	20
	GF 109	32mm x No.8	20
	 EMJAY GROMMET	RG 4	13mm
RG 5		15mm	100
RG 6		20mm	100
RG 8		25mm	100
 FULL FLOW GROMMET FITTING	FF 1202	13mm x No. 5	20
	FF 1200	13mm x No. 6	20
	FF 1205	15mm x No. 5	20
	FF 1210	15mm x No. 6	20
	FF 1215	20mm x No. 5	20
	FF 1220	20mm x No. 6	20

EMJAY® FILTERS & SPARES

DESCRIPTION	CODE	SIZE	PACK	
 EMJAY IN-LINE FILTER	MB 159	13mm	20	
	MB 159(B)	13mm	20	
	MB 160	15mm	20	
	MB 160 (B)	15mm	20	
	MB 161	20mm	20	
	MB 161 (B)	20mm	20	
EMJAY IN-LINE FILTER CARTRIDGE & WASHER	MB 162		20	
 SERIES 3000 INLINE FILTER (COMPLETE WITH ELEMENT AND ENDS)	MBF 04	20mm FULL FLOW ENDS	1	
	MBF 05	25mm FULL FLOW ENDS	1	
	MBF 14	20mm INSERT ENDS	1	
	MBF 15	25mm INSERT ENDS	1	
	MBF 24	3/4" BSP ENDS	1	
	MBF 25	1" BSP ENDS	1	
	<i>The above are available in Clear (C suffix) or Black (B suffix) with 80 mesh (80 suffix) or 120 mesh (120 suffix) elements eg: MBF04C80 = 20mm Full Flow, Clear Barrel, 80 Mesh Element</i>			
SERIES 3000 SPARES 	MBF 330	30 MESH (Black)	1	
	MBF 380	80 MESH (Yellow)	1	
	MBF 3120	120 MESH (Blue)	1	
	BARREL	MBF 31C	Clear	1
	BARREL	MBF 31B	Black	1
	NUTS (SOLD IN PAIRS)	MBF 32	Price per Pair	1
	RIBBED CAP	MBF 33		1
	POLYPIPE STOP	MBF 34		1
	SEAL KIT	MBF 35	consists of 5 seals	1
	ENDS (SOLD IN PAIRS)	MBF 304	20mm FULL FLOW ENDS	1
		MBF 305	25mm FULL FLOW ENDS	1
		MBF 314	20mm INSERT ENDS	1
		MBF 315	25mm INSERT ENDS	1
		MBF 324	3/4" BSP ENDS	1
		MBF 325	1" BSP ENDS	1



DESCRIPTION	CODE	SIZE	PACK
 MALE THREADED TEE PIECE	MBP 350 MBP 355 MBP 360	1/2" BSP 3/4" BSP 1" BSP	20 20 20
 MALE THREADED ELBOW	MBP 370 MBP 375 MBP 380 MBP 382	1/2" BSP 3/4" BSP 1" BSP 1 1/2" BSP	20 20 20 20
 MALE THREADED PLUG	MBP 391 MBP 392 MBP 393 MBP 394 MBP 395 MBP 396	1/2" 3/4" 1" 1 1/4" 1 1/2" 2"	20 20 20 20 20 10
 NIPPLE	MBP 500 MBP 505 MBP 510 MBP 511 MBP 512 MBP 513	1/2" BSP (15mm) 3/4" BSP (20mm) 1" BSP (25mm) 1 1/4" BSP (32mm) 1 1/2" BSP (40mm) 2" BSP (50mm)	20 20 20 20 20 10
 REDUCING NIPPLE	MBP 520 MBP 524 MBP 525 MBP 528 MBP 531 MBP 532 MBP 537	3/4" x 1/2" (20 x 15mm) 1" x 1/2" (25 x 15mm) 1" x 3/4" (25 x 20mm) 1 1/4" x 1" (32 x 25mm) 1 1/2" x 1" (40 x 25mm) 1 1/2" x 1 1/4" (40 x 32mm) 2" x 1 1/2" (50 x 40mm)	20 20 20 20 20 20 10
 REDUCING BUSH	MBP 622 MBP 623 MBP 624 MBP 625 MBP 626 MBP 627 MBP 628 MBP 629 MBP 630 MBP 631 MBP 632 MBP 633 MBP 634 MBP 635 MBP 636 MBP 637	3/4" x 1/4" (20 x 8mm) 3/4" x 1/2" (20 x 15mm) 1" x 1/2" (25 x 15mm) 1" x 3/4" (25 x 20mm) 1 1/4" x 1/2" (32 x 15mm) 1 1/4" x 3/4" (32 x 20mm) 1 1/4" x 1" (32 x 25mm) 1 1/2" x 1/2" (40 x 15mm) 1 1/2" x 3/4" (40 x 20mm) 1 1/2" x 1" (40 x 25mm) 1 1/2" x 1 1/4" (40 x 32mm) 2" x 1/2" (50 x 15mm) 2" x 3/4" (50 x 20mm) 2" x 1" (50 x 25mm) 2" x 1 1/4" (50 x 32mm) 2" x 1 1/2" (50 x 40mm)	20 20 20 20 20 20 20 20 20 20 20 10 10 10 10 10









This Supercedes ALL Previous Catalogues



DESCRIPTION	CODE	SIZE	PACK
 SOCKET	MBP 651	1/2" BSP (15mm)	20
	MBP 652	3/4" BSP (20mm)	20
	MBP 653	1" BSP (25mm)	20
	MBP 654	1 1/4" BSP (32mm)	20
	MBP 655	1 1/2" BSP (40mm)	20
	MBP 656	2" BSP (50mm)	10
	BK 50	1/2" BSP SHORT SOCKET (ABS)	20
 REDUCING SOCKET	MBP 660	3/4" x 1/2" (20 x 15mm)	20
	MBP 661	1" x 1/2" (25 x 15mm)	20
	MBP 662	1" x 3/4" (25 x 20mm)	20
	MBP 665	1 1/4" x 1" (32mm x 25mm)	20
	MBP 668	1 1/2" x 1" (40mm x 25mm)	20
 IMPACT SOCKET - Green - with offset threads	MBP 681	1/2" BSP (15mm)	20
	MBP 682	3/4" BSP (20mm)	20
 MALE TO FEMALE ELBOW	MBP 754	1/2" (15mm)	20
	MBP 755	3/4" (20mm)	20
	MBP 756	1" (25mm)	20
 FEMALE END CAP	MBP 790	1/2" BSP (15mm)	20
	MBP 791	3/4" BSP (20mm)	20
	MBP 792	1" BSP (25mm)	20
	MBP 793	1 1/4" BSP (32mm)	20
	MBP 794	1 1/2" BSP (40mm)	20
	MBP 795	2" BSP (50mm)	10
 FEMALE TEE PIECE	MBP 801	1/2" BSP (15mm)	20
	MBP 802	3/4" BSP (20mm)	20
	MBP 803	1" BSP (25mm)	20
	MBP 804	1 1/4" BSP (32mm)	20
	MBP 805	1 1/2" BSP (40mm)	20
	MBP 806	2" BSP (50mm)	10
 FEMALE ELBOW	MBP 811	1/2" BSP (15mm)	20
	MBP 812	3/4" BSP (20mm)	20
	MBP 813	1" BSP (25mm)	20
	MBP 814	1 1/4" BSP (32mm)	20
	MBP 815	1 1/2" BSP (40mm)	20
	MBP 816	2" BSP (50mm)	10

This Supersedes ALL Previous Catalogues







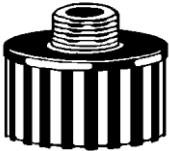
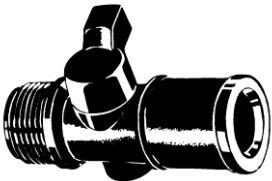
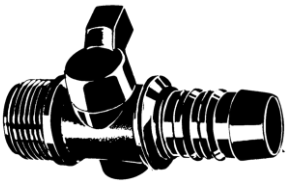
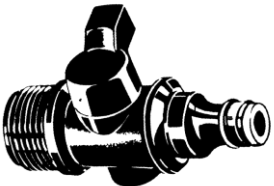

DESCRIPTION	CODE	SIZE	PACK
 <p>MANIFOLD TEE PIECE</p>	MM 100 MM 101	MALE 1" BSP UNION -1" BSP incl. manifold nipple	20 20
 <p>MANIFOLD CROSS PIECE</p>	MM 110 MM 111	MALE 1" BSP UNION -1" BSP incl. manifold nipple	20 20
 <p>MANIFOLD ELBOW</p>	MM 120 MM 121	MALE 1" BSP UNION -1" BSP incl. manifold nipple	20 20
 <p>MANIFOLD INLET (MALE - No Coupling Required)</p>	MM 130	1" BSP - MALE	20
 <p>MANIFOLD END CAP (MALE - No Coupling Required)</p>	MM 140		20
 <p>MANIFOLD COUPLING</p>	MM 150		20
 <p>MANIFOLD CLIP</p>	MM 160 MM 161	Plain Clip Wall Mount Clip	20 20
 <p>MANIFOLD NIPPLE</p>	MM 170	1" BSP / ACME	20
 <p>MANIFOLD VALVE ADAPTOR</p>	MM 180 MM185	UNION - 1" BSP UNION - 1" BSP incl Nipple (Male)	20 20
 <p>ASSEMBLED UNION MANIFOLD (1" BSP)</p>	MM 250 MM 251 MM 252 MM 253 MM 254 MM 255 MM 256	EXTENSION KIT (Tee, Coupling, Clips) 1 STATION 2 STATION 3 STATION 4 STATION 5 STATION 6 STATION	1 1 1 1 1 1 1

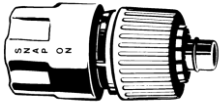
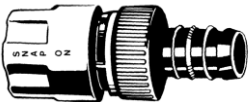

DESCRIPTION	CODE	SIZE	PACK
 UNIVERSAL SHRUB ADAPTOR	PA 100	1/2" BSP (for presfit jets)	20
	PA 200	1/2" BSP x 2BA (for microjets)	20
	PA 400	1/2" BSP	20
 SHUT-OFF VALVES FULL FLOW	VF 100	13mm x 3/4"	20
	VF 110	15mm x 3/4"	20
	VF 120	20mm x 3/4"	20
 SHUT-OFF VALVES: INSERT & THREADED	VB 100	13mm x 3/4"	20
	VB 115	13/15mm x 3/4"	20
	VB 110	15mm x 3/4"	20
	VB 120	20mm x 3/4"	20
 SHUT-OFF VALVES: SNAP-ON	VS 100	3/4"	20



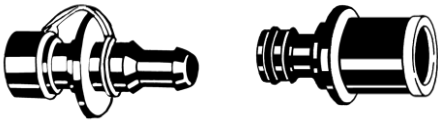

This Supersedes ALL Previous Catalogues



DESCRIPTION	CODE	SIZE	PACK
 TAP CONNECTOR	SB 110 SB 120 SB 130 SB 140	1/2" 5/8" 3/4" 7/8"	20 20 20 20
 HOSE CONNECTOR	SB 220	1/2" Hose	20
 SNAP-ON/ EMJAY HOSE CONNECTOR	SB 224 SB 225	1/2" Hose (15mm) 3/4" Hose (20mm)	20 20
 ACCESSORY ADAPTOR	SB 250 SB 260	3/4" BSP 3/4" USA	20 20
 HOSE JOINER	SB 270		20
 HOSEMENDER	SB 290	1/2" Hose (15mm)	20
 POLYPIPE CONNECTOR COUPLING	SB 300 SB 305 SB 310 SB 320 SB 330	13/15mm Insert 20mm Insert 13mm Full Flow 15mm Full Flow 20mm Full Flow	20 20 20 20 20
 SNAP-ON / FULL FLOW CONNECTOR	SB 350 SB 360 SB 370	13mm 15mm 20mm	20 20 20
 SNAP-ON SPRAY NOZZLE	SB 500		20

This Supersedes ALL Previous Catalogues

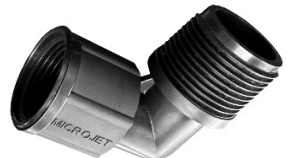

DESCRIPTION	CODE	SIZE	PACK	S.R.P (each)	
 <p>POLY STAND PIPE 15MM (1/2" BSP MALE THREAD)</p>	PRM150025	1/2" BSP (15mm) x 25mm	20		
	PRM150050	1/2" BSP (15mm) x 50mm	20		
	PRM150080	1/2" BSP (15mm) x 80mm	20		
	PRM150100	1/2" BSP (15mm) x 100mm	20		
	PRM150150	1/2" BSP (15mm) x 150mm	20		
	PRM150200	1/2" BSP (15mm) x 200mm	20		
	PRM150300	1/2" BSP (15mm) x 300mm	30		
	PRM150400	1/2" BSP (15mm) x 400mm	30		
	PRM150450	1/2" BSP (15mm) x 450mm	30		
	PRM150500	1/2" BSP (15mm) x 500mm	30		
	PRM150600	1/2" BSP (15mm) x 600mm	30		
	PRM150750	1/2" BSP (15mm) x 750mm	30		
	PRM150900	1/2" BSP (15mm) x 900mm	30		
	PRM151000	1/2" BSP (15mm) x 1000mm	30		
	PRM151200	1/2" BSP (15mm) x 1200mm	30		
	 <p>POLY STAND PIPE 20MM (3/4" BSP MALE THREAD)</p>	PRM200050	3/4" BSP (20mm) x 50mm	20	
		PRM200080	3/4" BSP (20mm) x 80mm	20	
PRM200150		3/4" BSP (20mm) x 150mm	20		
PRM200200		3/4" BSP (20mm) x 200mm	20		
PRM200300		3/4" BSP (20mm) x 300mm	20		
PRM200400		3/4" BSP (20mm) x 400mm	20		
PRM200450		3/4" BSP (20mm) x 450mm	20		
PRM200500		3/4" BSP (20mm) x 500mm	20		
PRM200600		3/4" BSP (20mm) x 600mm	20		
PRM200750		3/4" BSP (20mm) x 750mm	20		
PRM200900		3/4" BSP (20mm) x 900mm	20		
PRM201000		3/4" BSP (20mm) x 1000mm	20		
PRM201200		3/4" BSP (20mm) x 1200mm	20		
 <p>POLY STAND PIPE 25MM (1" BSP MALE THREAD)</p>	PRM250200	1" BSP (25mm) x 200mm	10		
	PRM250300	1" BSP (25mm) x 300mm	10		
	PRM250400	1" BSP (25mm) x 400mm	10		
	PRM250500	1" BSP (25mm) x 500mm	10		
	PRM250600	1" BSP (25mm) x 600mm	10		
	PRM250750	1" BSP (25mm) x 750mm	10		
	PRM250900	1" BSP (25mm) x 900mm	10		
	PRM251000	1" BSP (25mm) x 1000mm	10		
 <p>MALE/FEMALE ELBOW FOR SWING JOINT</p>	PRE1515	1/2" BSP (15mm)	20		
	PRE2020	3/4" BSP (20mm)	20		
	PRE2525	1" BSP (25mm)	20		
 <p>SWING JOINT (ARTICULATED RISER)</p>	PRA15200	1/2" BSP (15mm) x 200mm	10		
	PRA15300	1/2" BSP (15mm) x 300mm	10		
	PRA20200	3/4" BSP (20mm) x 200mm	10		
	PRA20300	3/4" BSP (20mm) x 300mm	5		
	PRA25300	1" BSP (25mm) x 300mm	5		

This Supercedes ALL Previous Catalogues